



60B400

**PARTS
MANUAL**



32" FRONT DECK ASSEMBLY

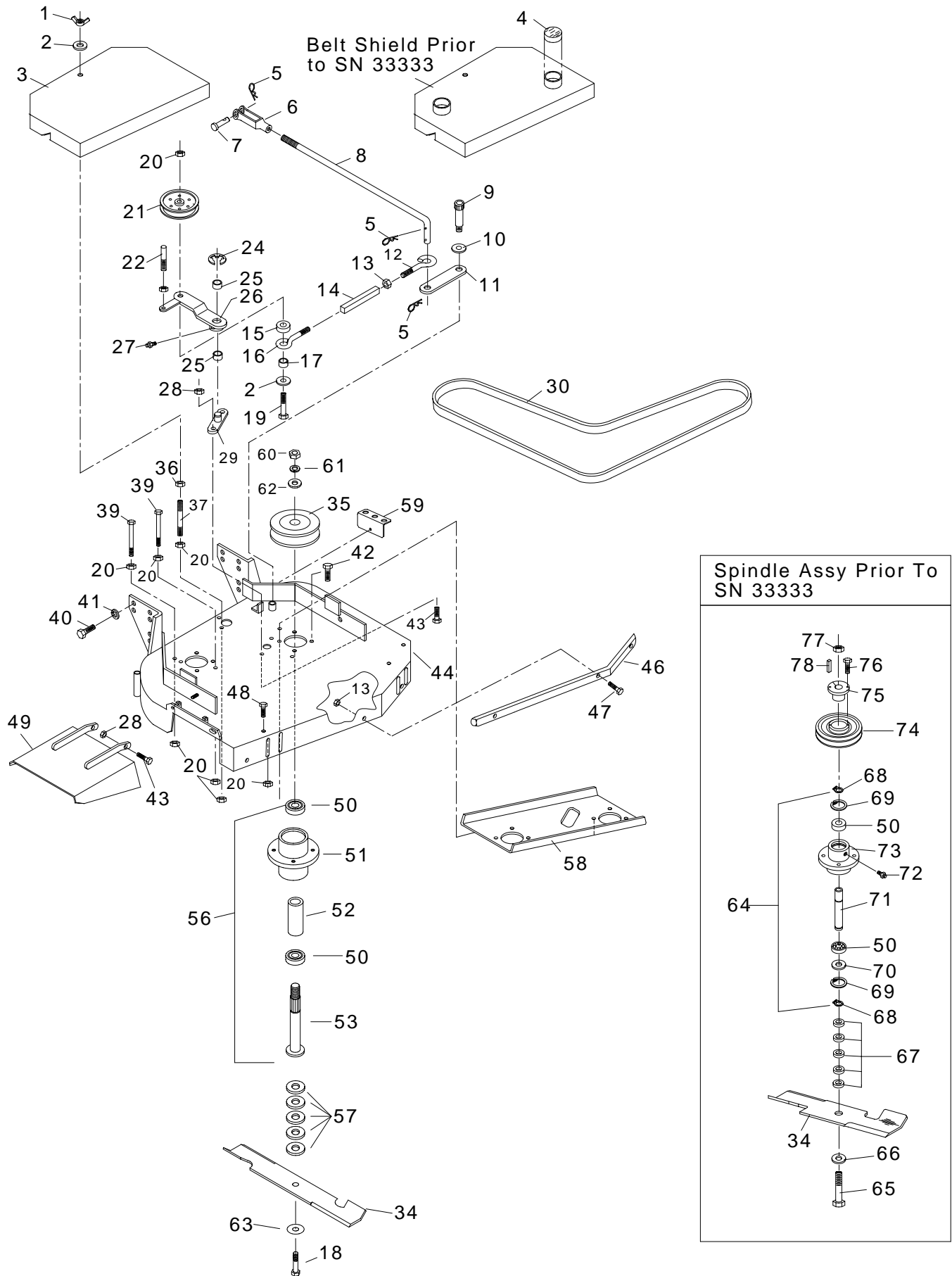

BELT DRIVE WALK BEHIND 32" FRONT DECK ASSEMBLY

SEE NOTES

#	PART NO.	QTY	DESCRIPTION
1	103027	3	3/8" WING NUT
2	105260	4	3/8" STD. FLAT WASHER
3	322002	1	BELT COVER
4	363161	2	BELT COVER CAP
5	363165	3	HAIRPIN COTTER
6	363192	1	LARGE YOKE
7	363196	1	CLEVIS PIN
8	323002	1	BLADE DRIVE LINKAGE
9	109014	1	SHOULDER BOLT
10	363240	1	SHOULDER SPACER
11	363085	1	CAM LINK
12	363080	1	RIGHT EYEBOLT
13	109001	4	5/16" WHIZLOCK NUT
14	363172	1	TURNBUCKLE BODY
15	363097	1	TURNBUCKLE SPACER
16	363082	1	LEFT EYEBOLT
17	363174	1	EYEBOLT SPACER
18A	100356	2	5/8"-11 X 1 1/2" HEX BOLT
18B	100358	2	5/8"-11 X 2 1/4" HEX BOLT
19	100298	1	3/8" X 2 1/2" BOLT
20	109007	18	3/8" WHIZLOCK NUT
21	363264	1	ENGAGEMENT IDLER (WF)
22	363249	1	BELT SNUBBER
24	108509	1	"E" RING
25	363089	2	BRONZE BUSHING
26	362071	1	ENGAGEMENT ARM W/BUSHING
27	111004	1	1/4" - 28 ZERK
28	104256	14	5/16" NYLOC HEX NUT
29	362024	1	IDLER PIVOT ASSY.
30	323003	1	BLADE DRIVE BELT
34	483035	2	16" BLADE
35	363378	2	RAISED PULLEY
36	104257	1	3/8" NYLOC HEX NUT
37	363090	2	BELT SHIELD SUPPORT
39	100306	4	3/8" X 5" HEX BOLT
40	100309	6	7/16" 1" HEX BOLT
41	105007	6	7/16" LOCK WASHER
42	100274	8	5/16" X 1 1/4" HEX BOLT
43	100273	8	5/16" X 1" HEX BOLT
44	322004	1	32" FRONT DECK
45	109014	1	SHOULDER BOLT
46	323029	1	SQUARE BUMPER
47	100276	3	5/16" X 1 3/4" HEX BOLT
48	100292	6	3/8" X 1" HEX BOLT
49	362012	1	GRASS DEFLECTOR

BELT DRIVE WALK BEHIND 32" FRONT DECK ASSEMBLY

SEE NOTES

#	PART NO.	QTY	DESCRIPTION	
50	363350	4	SPINDLE BEARING	
51	363380	2	BLADE SPINDLE HOUSING	
52	583113	2	BEARING SPACER TUBE	
53	583112	2	SPINDLE SHAFT	
56	363379	2	SPINDLE ASSY COMPLETE	
57	363382	10	BLADE SPACER	
58	323031	1	32" DECK CHANNEL	
59	322019	1	SPACER BRACKET	
60	104511	2	3/4"-16 HEX NUT	
61	105010	2	3/4" LOCK WASHER	
62	105269	2	3/4" S.A.E. FLAT WASHER	
63	583108	2	5/8" DISC SPRING WASHER	
64	362044	2	CUTTER HOUSING ASSY	1
65	100353	2	5/8" X 9 1/2" HEX BOLT	1
66	105268	2	5/8" STD. FLAT WASHER	1
67	363170	10	BLADE SPACER	1
68	108507	4	1" RETAINING RING	1
69	108506	4	INT. SNAP RING	1
70	363060	2	DUST CAP	1
71	363058	2	SPINDLE	1
72	111002	2	5/16" DRIVE ZERK	1
73	363053	2	BLADE SPINDLE HOUSING	1
74	363216	2	TAPER LOCK SHEAVE	1
75	363217	2	TAPER LOCK HUB	1
76	100252	4	1/4" X 3/4" HEX BOLT	1
77	104510	2	5/8"-11 HEX NUT	1
78	363242	2	BLADE SPINDLE KEY	1

NOTES:

1: Item refers to units prior to serial #33333

36" FRONT DECK ASSEMBLY

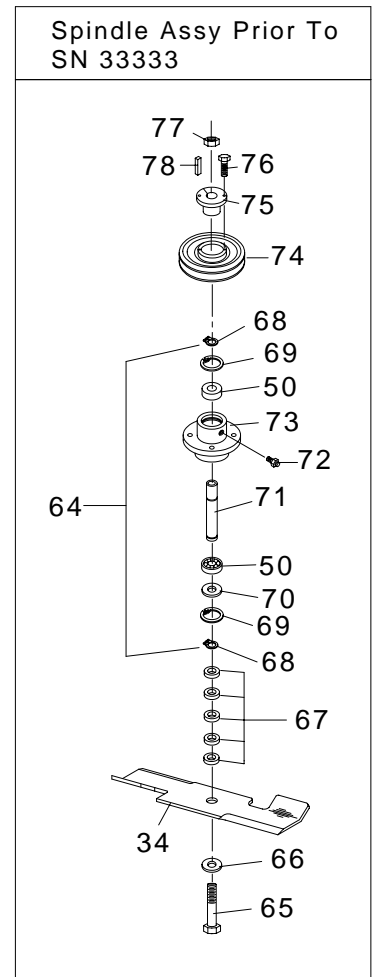
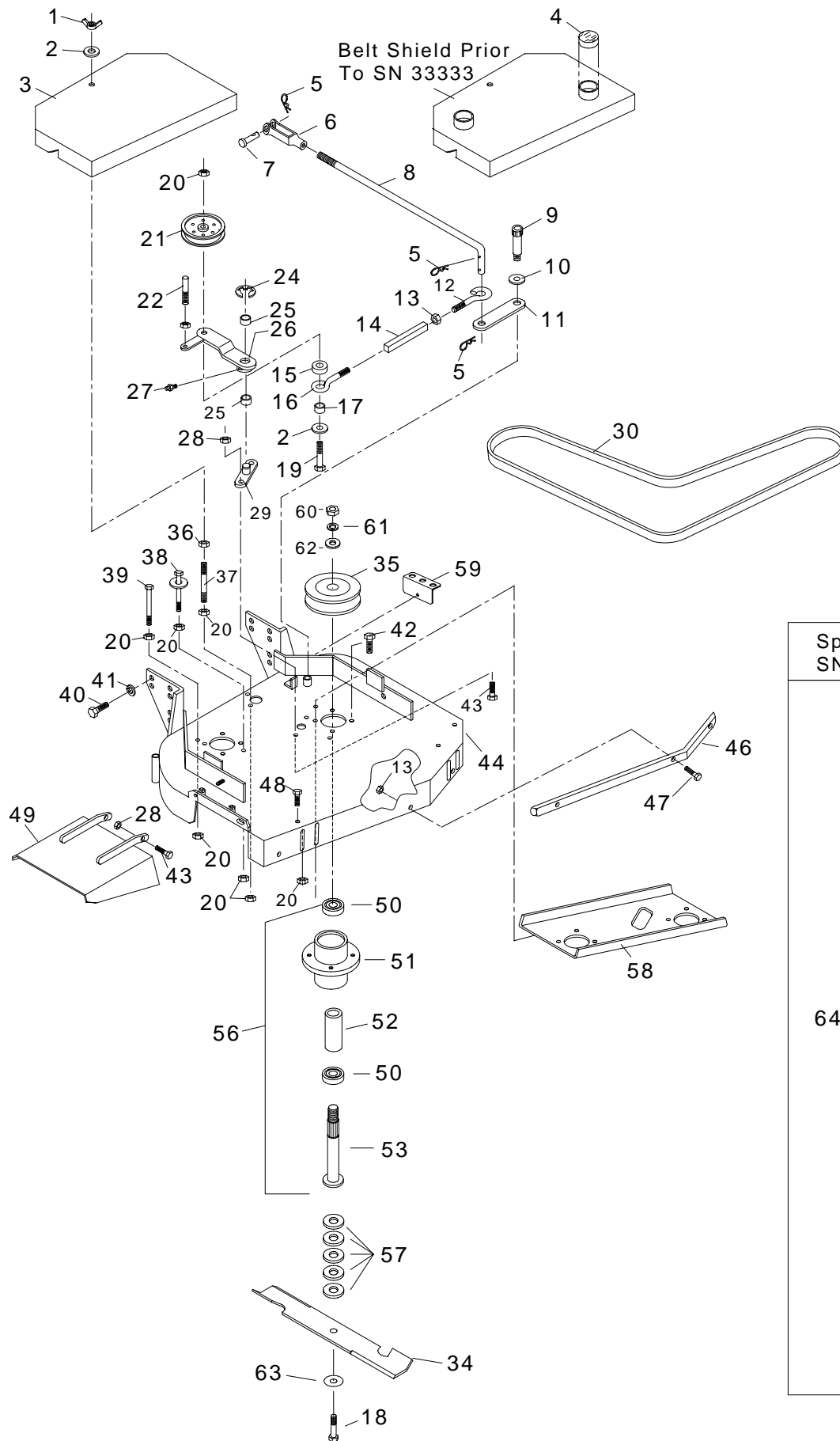

BELT DRIVE WALK BEHIND 36" FRONT DECK ASSEMBLY

SEE NOTES

#	PART NO.	QTY	DESCRIPTION
1	103027	3	3/8" WING NUT
2	105260	4	3/8" STD. FLAT WASHER
3	362043	1	BELT COVER
4	363161	2	BELT COVER CAP
5	363165	3	HAIRPIN COTTER
6	363192	1	LARGE YOKE
7	363196	1	CLEVIS PIN
8	363194	1	BLADE DRIVE LINKAGE
9	109014	1	SHOULDER BOLT
10	363240	1	SHOULDER SPACER
11	363085	1	CAM LINK
12	363080	1	RIGHT EYEBOLT
13	109001	4	5/16" WHIZLOCK NUT
14	363172	1	TURNBUCKLE BODY
15	363097	1	TURNBUCKLE SPACER
16	363082	1	LEFT EYEBOLT
17	363174	1	EYEBOLT SPACER
18A	100356	2	5/8"-11 X 1 1/2" HEX BOLT
18B	100358	2	5/8"-11 X 2 1/4" HEX BOLT
19	100298	1	3/8" X 2 1/2" BOLT
20	109007	18	3/8" WHIZLOCK NUT
21	363264	1	ENGAGEMENT IDLER (WF)
22	363249	1	BELT SNUBBER
24	108509	1	"E" RING
25	363089	2	BRONZE BUSHING
26	362071	1	ENGAGEMENT ARM W/BUSHING
27	111004	1	1/4" - 28 ZERK
28	104256	14	5/16" NYLOC HEX NUT
29	362024	1	IDLER PIVOT ASSY.
30	363210	1	BLADE DRIVE BELT
34	363291	2	18" BLADE
35	363378	2	RAISED PULLEY
36	104257	1	3/8" NYLOC HEX NUT
37	363090	2	BELT SHIELD SUPPORT
38	362018	2	FRONT BELT GUIDE
39	100306	2	3/8" X 5" HEX BOLT
40	100309	6	7/16" 1" HEX BOLT
41	105007	6	7/16" LOCK WASHER
42	100274	8	5/16" X 1 1/4" HEX BOLT
43	100273	8	5/16" X 1" HEX BOLT
44	362007	1	36" FRONT DECK
45	109014	1	SHOULDER BOLT
46	363304	1	SQUARE BUMPER
47	100276	3	5/16" X 1 3/4" HEX BOLT
48	100292	6	3/8" X 1" HEX BOLT

BELT DRIVE WALK BEHIND 36" FRONT DECK ASSEMBLY

SEE NOTES

#	PART NO.	QTY	DESCRIPTION	
49	362012	1	GRASS DEFLECTOR	
50	363350	4	SPINDLE BEARING	
51	363380	2	BLADE SPINDLE HOUSING	
52	583113	2	BEARING SPACER TUBE	
53	583112	2	SPINDLE SHAFT	
56	363379	2	SPINDLE ASSY COMPLETE	
57	363382	10	BLADE SPACER	
58	363301	1	36" DECK CHANNEL	
59	322019	1	SPACER BRACKET	
60	104511	2	3/4"-16 HEX NUT	
61	105010	2	3/4" LOCK WASHER	
62	105269	2	3/4" S.A.E. FLAT WASHER	
63	583108	2	5/8" DISC SPRING WASHER	
64	362044	2	CUTTER HOUSING ASSY	1
65	100353	2	5/8" X 9 1/2" HEX BOLT	1
66	105268	2	5/8" STD. FLAT WASHER	1
67	363170	10	BLADE SPACER	1
68	108507	4	1" RETAINING RING	1
69	108506	4	INT. SNAP RING	1
70	363060	2	DUST CAP	1
71	363058	2	SPINDLE SHAFT	1
72	111002	2	5/16" DRIVE ZERK	1
73	363053	2	BLADE SPINDLE HOUSING	1
74	363216	2	TAPER LOCK SHEAVE	1
75	363217	2	TAPER LOCK HUB	1
76	100252	4	1/4" X 3/4" HEX BOLT	1
77	104510	2	5/8"-11 HEX NUT	1
78	363242	2	BLADE SPINDLE KEY	1

NOTES:

1: Item refers to units prior to serial #33333

48" FRONT DECK ASSEMBLY

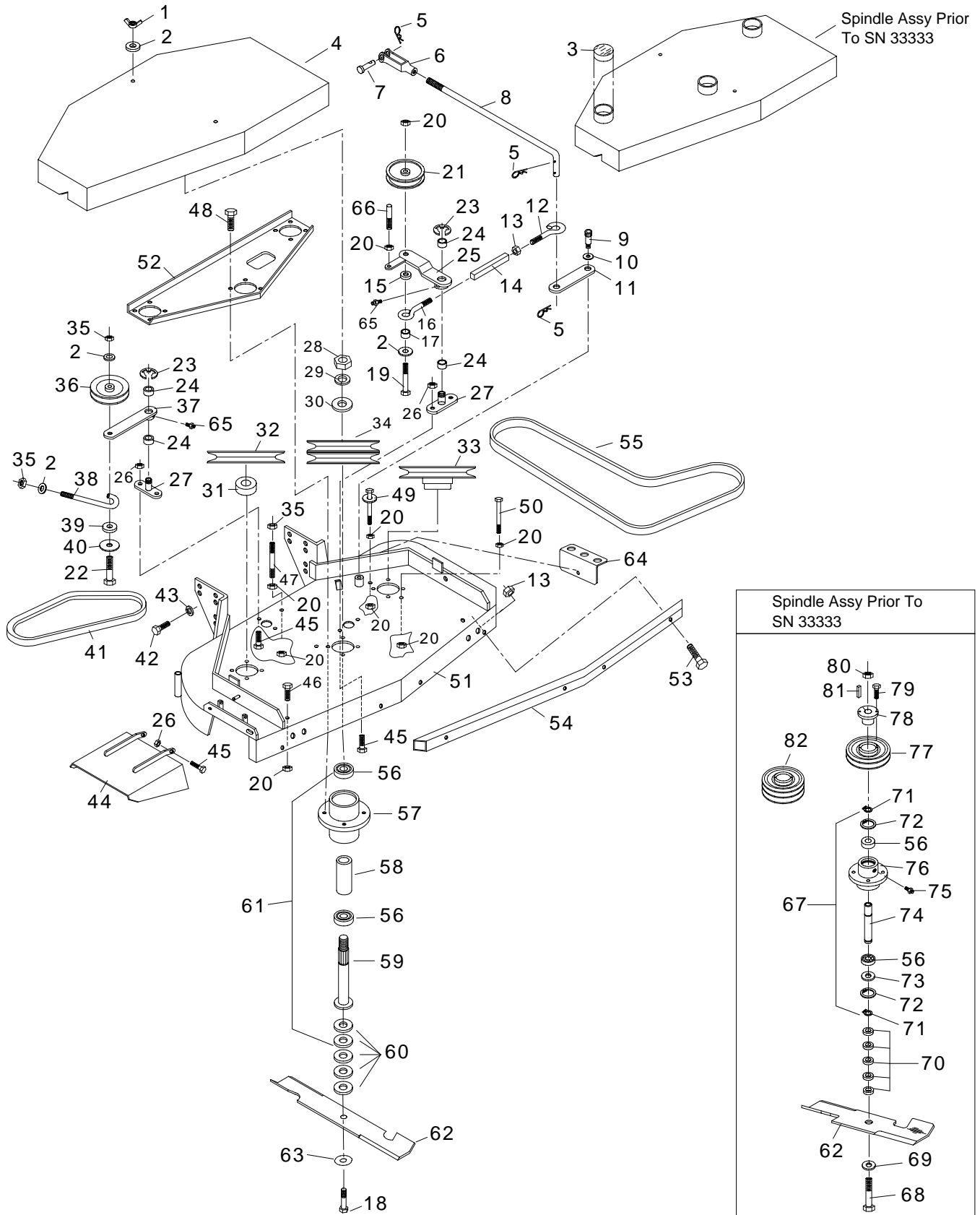

BELT DRIVE WALK BEHIND 48" FRONT DECK ASSEMBLY

SEE NOTES

#	PART NO.	QTY	DESCRIPTION
1	103027	3	3/8" WING NUT
2	105260	4	3/8" STD. FLAT WASHER
3	362043	1	BELT COVER
4	363161	2	BELT COVER CAP
5	363165	3	HAIRPIN COTTER
6	363192	1	LARGE YOKE
7	363196	1	CLEVIS PIN
8	483028	1	BLADE DRIVE LINKAGE
9	109014	1	SHOULDER BOLT
10	363240	1	SHOULDER SPACER
11	363085	1	CAM LINK
12	363080	1	RIGHT EYEBOLT
13	109001	4	5/16" WHIZLOCK NUT
14	363172	1	TURNBUCKLE BODY
15	363097	1	TURNBUCKLE SPACER
16	363082	1	LEFT EYEBOLT
17	363174	1	EYEBOLT SPACER
18A	100356	2	5/8"-11 X 1 1/2" HEX BOLT
18B	100358	2	5/8"-11 X 2 1/4" HEX BOLT
19	100298	1	3/8" X 2 1/2" BOLT
20	109007	18	3/8" WHIZLOCK NUT
21	363264	1	ENGAGEMENT IDLER (WF)
22	100297	1	3/8" x 2 1/4" HEX BOLT
23	108509	1	"E" RING
24	363089	4	BRONZE BUSHING
25	362071	1	ENGAGEMENT ARM W/BUSHING
26	104256	15	5/16" NYLOC HEX NUT
27	362024	2	IDLER PIVOT ASSY.
28	104511	3	3/4"-16 HEX NUT
29	105010	3	3/4" LOCK WASHER
30	105269	3	3/4" S.A.E. FLAT WASHER
31	583110	1	PULLEY SPACER
32	583107	1	PULLEY
33	363378	1	RAISED PULLEY
34	363377	1	DOUBLE PULLEY
35	104257	3	3/8" NYLOC HEX NUT
36	483025	1	RIGHT HAND IDLER PULLEY
37	482005	1	IDLER ARM RIGHT
38	483003	1	BELT TENSION ROD
39	483017	1	RIGHT HAND IDLER SPACER
40	483019	1	RIGHT HAND IDLER WASHER
41	483031	1	RIGHT HAND BLADE BELT
42	100309	6	7/16" X 1" HEX BOLT
43	105007	6	7/16" LOCK WASHER
44	482017	1	GRASS DEFLECTOR

BELT DRIVE WALK BEHIND 48" FRONT DECK ASSEMBLY

SEE NOTES

#	PART NO.	QTY	DESCRIPTION	
45	100273	8	5/16" X 1" HEX BOLT	
46	100292	8	3/8" X 1" HEX BOLT	
47	363090	1	BE.T SHIELD SUPPORT	
48	100274	12	5/16" X 1 1/4" HEX BOLT	
49	362018	1	FRONT BELT GUIDE	
50	100306	3	3/8" X 5" HEX BOLT	
51	482019	1	48" FRONT DECK	
52	482015	1	48" DECK CHANNEL	
53	100276	4	5/16" X 1 3/4" HEX BOLT	
54	483043	1	SQUARE BUMPER	
55	483030	1	BLADE DRIVE BELT	
56	363350	6	SPINDLE BEARING	
57	363380	3	BLADE SPINDLE HOUSING	
58	583113	3	BEARING SPACER TUBE	
59	583112	3	SPINDLE SHAFT	
60	363382	15	BLADE SPACER	
61	363379	3	CUTTER HOUSING ASSY	
62	483035	3	16" BLADE	
63	583108	3	5/8" DISC SPRING WASHER	
64	322019	1	SPACER BRACKET	
65	322019	2	1/4" ZERK	
66	363249	1	BELT SNUBBER	
67	362044	3	CUTTER HOUSING ASSY	1
68	100353	3	5/8" X 9 1/2" HEX BOLT	1
69	105268	3	5/8" STD. FLAT WASHER	1
70	363170	15	BLADE SPACER	1
71	108507	6	1" RETAINING RING	1
72	108506	6	INT. SNAP RING	1
73	363060	3	DUST CAP	1
74	363058	3	SPINDLE SHAFT	1
75	111002	3	5/16" DRIVE ZERK	1
76	363053	3	BLADE SPINDLE HOUSING	1
77	363216	2	TAPER LOCK SHEAVE	1
78	363217	3	TAPER LOCK HUB	1
79	100252	6	1/4" X 3/4" HEX BOLT	1
80	104510	3	5/8"-11 HEX NUT	1
81	363242	3	BLADE SPINDLE KEY	1
82	483026	1	TAPER LOCK DBLE SHEAVE	1

NOTES:

1: Item refers to units prior to serial #33333

52" FRONT DECK ASSEMBLY



BELT DRIVE WALK BEHIND 52" FRONT DECK ASSEMBLY

SEE NOTES

#	PART NO.	QTY	DESCRIPTION
1	103027	4	3/8" WING NUT
2	105260	6	3/8" STD. FLAT WASHER
3	363161	3	BELT COVER CAP
4	522138	1	BELT SHIELD ASSY
5	363165	3	HAIRPIN COTTER
6	363192	1	LARGE YOKE
7	363196	1	CLEVIS PIN
8	363194	1	BLADE DRIVE LINKAGE
9	363240	1	SHOULDER SPACER
10	603023	1	ROLLER
11	363085	1	CAM LINK
12	363080	1	RIGHT EYEBOLT
13	109001	5	5/16" WHIZLOCK NUT
14	363172	1	TURNBUCKLE BODY
15	363097	1	TURNBUCKLE SPACER
16	363082	1	LEFT EYEBOLT
17	363174	1	EYEBOLT SPACER
18	100352	1	5/8" X 9" HEX BOLT
19	100298	1	3/8" X 2 1/2" HEX BOLT
20	109007	12	3/8" WHIZLOCK NUT
21	363264	1	ENGAGEMENT IDLER (WF)
22	100297	1	3/8" X 2 1/4" HEX BOLT
23	108509	1	"E" RING
24	363089	4	BRONZE BUSHING
25	362071	1	ENGAGEMENT ARM W/BUSHING
26	104256	15	5/16" NYLOC HEX NUT
27	362024	2	IDLER PIVOT ASSY.
28	104511	3	3/4" HEX NUT
29	105010	3	3/4" LOCK WASHER
30	105269	3	3/4" S.A.E. FLAT WASHER
31	583110	1	PULLEY SPACER
32	583107	1	PULLEY
33	363378	1	RAISED PULLEY
34	363377	1	DOUBLE PULLEY
35	104257	3	3/8" NYLOC HEX NUT
36	483025	1	RIGHT HAND IDLER PULLEY
37	482005	1	IDLER ARM RIGHT
38	483003	1	BELT TENSION ROD
39	483017	1	RIGHT HAND IDLER SPACER
40	483019	1	RIGHT HAND IDLER WASHER
41	523453	1	RIGHT HAND BLADE BELT
42	100309	6	7/16" X 1" HEX BOLT
43	105007	6	7/16" LOCK WASHER
44	482017	1	GRASS DEFLECTOR
45	100273	8	5/16" X 1" HEX BOLT

BELT DRIVE WALK BEHIND 52" FRONT DECK ASSEMBLY

SEE NOTES

#	PART NO.	QTY	DESCRIPTION	
46	100292	8	3/8" X 1" HEX BOLT	
47	363090	1	BELT SHIELD SUPPORT	
48	100274	8	5/16" X 1 1/4" HEX BOLT	
49	523464	1	RIGHT HAND BUMPER	
50	100306	4	3/8" X 5" HEX BOLT	
51	522140	1	52" FRONT DECK	
52	522146	1	DECK CHANNEL	
53	100276	4	5/16" X 1 3/4" HEX BOLT	
54	523464	1	LEFT HAND BUMPER	
55	523452	1	BLADE DRIVE BELT	
56	363350	6	SPINDLE BEARING	
57	363380	3	BLADE SPINDLE HOUSING	
58	583113	3	BEARING SPACER TUBE	
59	583112	3	SPINDLE SHAFT	
60	363382	15	BLADE SPACER	
61	363379	3	CUTTER HOUSING ASSY	
62	363291	3	18" BLADE	
63	583108	3	5/8" DISC SPRING WASHER	
64A	100356	3	5/8"-11 X 1 1/2" HEX BOLT	
64B	100358	3	5/8"-11 X 2 1/4" HEX BOLT	
65	323040	1	SPACER BRACKET	
66	111004	2	1/4" ZERK	
67	363249	1	BELT SNUBBER	1
68	105268	5	5/8" FLAT WASHER	1
69	104269	1	5/8" NYLOC NUT	1
70	109014	1	SHOULDER BOLT	1
71	362044	3	CUTTER HOUSING ASSY	1
72	100353	3	5/8" X 9 1/2" HEX BOLT	1
73	105268	3	5/8" STD. FLAT WASHER	1
74	363170	15	BLADE SPACER	1
75	108507	6	1" RETAINING RING	1
76	108506	6	INT. SNAP RING	1
77	363060	3	DUST CAP	1
78	363058	3	SPINDLE SHAFT	1
79	111002	3	5/16" DRIVE ZERK	1
80	363053	3	BLADE SPINDLE HOUSING	1
81	363216	2	TAPER LOCK SHEAVE	1
82	363217	3	TAPER LOCK HUB	1
83	100252	6	1/4" X 3/4" HEX BOLT	1
84	104510	3	5/8"-11 HEX NUT	1
85	363242	3	BLADE SPINDLE KEY	1
86	483026	1	TAPER LOCK DBLE SHEAVE	1

NOTES:

1: Item refers to units prior to serial #33333

60" FRONT DECK ASSEMBLY



BELT DRIVE WALK BEHIND 60" FRONT DECK ASSEMBLY

SEE NOTES

#	PART NO.	QTY	DESCRIPTION
1	103027	4	3/8" WING NUT
2	105260	6	3/8" STD. FLAT WASHER
3	363361	3	BELT COVER CAP
4	602008	1	BELT COVER
5	363165	3	HAIRPIN COTTER
6	363192	1	LARGE YOKE
7	363196	1	CLEVIS PIN
8	63014	1	BLADE DRIVE LINKAGE
9	363240	1	SHOULDER SPACER
10	603023	1	ROLLER
11	363085	1	CAM LINK
12	363080	1	RIGHT EYEBOLT
13	109001	5	5/16" WHIZLOCK NUT
14	363172	1	TURNBUCKLE BODY
15	363097	1	TURNBUCKLE SPACER
16	363082	1	LEFT EYEBOLT
17	363174	1	EYEBOLT SPACER
18A	100356	3	5/8"-11 X 1 1/2" HEX BOLT
18B	100358	3	5/8"-11 X 2 1/4" HEX BOLT
19	100298	1	3/8" X 2 1/2" BOLT
20	109007	12	3/8" WHIZLOCK NUT
21	363264	1	ENGAGEMENT IDLER (WF)
22	100297	1	3/8" x 2 1/4" HEX BOLT
23	108509	1	"E" RING
24	363089	4	BRONZE BUSHING
25	362071	1	ENGAGEMENT ARM W/BUSHING
26	104256	15	5/16" NYLOC HEX NUT
27	362024	2	IDLER PIVOT ASSY.
28	104511	3	3/4"-16 HEX NUT
29	105010	3	3/4" LOCK WASHER
30	105269	3	3/4" S.A.E. FLAT WASHER
31	583110	1	PULLEY SPACER
32	583107	1	PULLEY
33	363378	1	RAISED PULLEY
34	363377	1	DOUBLE PULLEY
35	104257	3	3/8" NYLOC HEX NUT
36	483025	1	RIGHT HAND IDLER PULLEY
37	482005	1	IDLER ARM RIGHT
38	483003	1	BELT TENSION ROD
39	483017	1	RIGHT HAND IDLER SPACER
40	483019	1	RIGHT HAND IDLER WASHER
41	603016	1	RIGHT HAND BLADE BELT

BELT DRIVE WALK BEHIND 60" FRONT DECK ASSEMBLY

SEE NOTES

#	PART NO.	QTY	DESCRIPTION	
42	100309	6	7/16" X 1" HEX BOLT	
43	105007	6	7/16" LOCK WASHER	
44	482017	1	GRASS DEFLECTOR	
45	100273	8	5/16" X 1" HEX BOLT	
46	100292	6	3/8" X 1" HEX BOLT	
47	363090	1	BELT SHIELD SUPPORT	
48	100274	12	5/16" X 1 1/4" HEX BOLT	
49	603038	1	RIGHT HAND BUMPER	
50	100306	3	3/8" X 5" HEX BOLT	
51	602011	1	60" FRONT DECK	
52	602010	1	60" DECK CHANNEL	
53	100276	4	5/16" X 1 3/4" HEX BOLT	
54	603040	1	LEFT HAND BUMPER	
55	603015	1	BLADE DRIVE BELT	
56	363350	6	SPINDLE BEARING	
57	363380	3	BLADE SPINDLE HOUSING	
58	583113	3	BEARING SPACER TUBE	
59	583112	3	SPINDLE SHAFT	
60	363382	15	BLADE SPACER	
61	363379	3	CUTTER HOUSING ASSY	
62	603035	3	20" BLADE	
63	583108	3	5/8" DISC SPRING WASHER	
64	100352	1	5/8" X 9" HEX BOLT	
65	322019	1	SPACER BRACKET	
66	111004	2	1/4" ZERK	
67	363249	1	BELT SNUBBER	
68	105268	5	5/8" FLAT WASHER	
69	104261	1	5/8" NYLOCK NUT	
70	109014	1	SHOULDER BOLT	
71	362044	3	CUTTER HOUSING ASSY	1
72	100353	3	5/8" X 9 1/2" HEX BOLT	1
73	105268	3	5/8" STD. FLAT WASHER	1
74	363170	15	BLADE SPACER	1
75	108507	6	1" RETAINING RING	1
76	108506	6	INT. SNAP RING	1
77	363060	3	DUST CAP	1
78	363058	3	SPINDLE SHAFT	1
79	111002	3	5/16" DRIVE ZERK	1
80	363053	3	SPINDLE HOUSING	1
81	363216	2	TAPER LOCK SHEAVE	1
82	363217	3	TAPER LOCK HUB	1
83	100252	6	1/4" X 3/4" HEX BOLT	1

BELT DRIVE WALK BEHIND 60" FRONT DECK ASSEMBLY

SEE NOTES

#	PART NO.	QTY	DESCRIPTION	
84	104510	3	5/8"-11 HEX NUT	1
85	363242	3	BLADE SPINDLE KEY	1
86	483026	1	TAPER LOCK DBLE SHEAVE	1

NOTES:

1: Item refers to units prior to serial #33333

REAR DECK ASSEMBLY

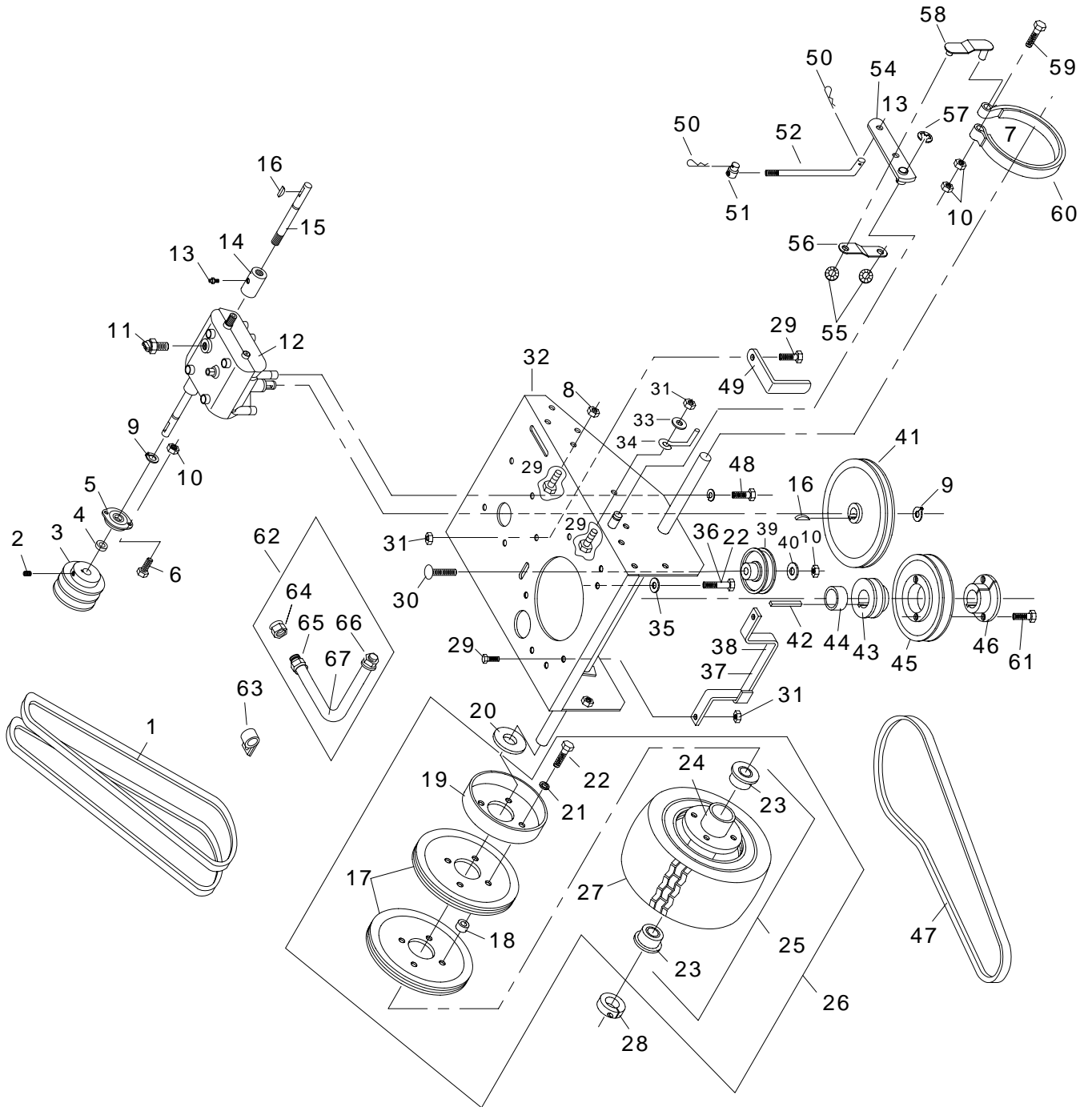

BELT DRIVE WALK BEHIND REAR DECK ASSEMBLY

SEE NOTES

#	PART NO.	QTY	DESCRIPTION	
1	363312	2	MATCH SET DRIVE BELT	
2	103293	2	5/16"-18 X 3/8" SET SCREW	
3	363137	2	2-GROOVE SHEAVE	
4	363087	2	TRANSMISSION SHAFT SPACER	
5	363292	2	2-BOLT FLANGE BEARING	
6	100292	4	3/8" X 1" HEX BOLT	
8	109001	2	5/16" WHIZLOCK NUT	
9	108508	3	SNAP RING	
10	104257	5	3/8" NYLOC HEX NUT	
11	363207	1	TRANSMISSION SWITCH	
12A	363365	1	TRANSMISSION 9-SPLINE	
12B	363180	1	TRANSMISSION 32-SPLINE	1
13	111004	3	1/4"-28 GREASE ZERK	
14A	362086	2	COUPLER W/ZERK 9-SPLINE	
14B	362063	2	COUPLER W/ZERK 32-SPLINE	1
15A	363367	2	SHAFT EXTENSION 9-SPLINE	
15B	363051	2	SHAFT EXTENSION 32-SPLINE	1
16	107009	3	#9 WOODRUFF KEY	
17	363191	4	WHEEL PULLEY	
18	363113	8	WHEEL PULLEY SPACER	
19	363190	2	BRAKE DRUM	
20	363121	2	WHEEL WASHER	
21	105005	8	5/16" MED WASHER	
22	100275	12	5/16" X 1 1/2" HEX BOLT (BRIGGS)	
23	363187	4	WHEEL BEARING	
24A	363189	2	RIM W/VALVE STEM	
24B	323026	2	RIM W/VALVE STEM (32")	
25	362055	2	WHEEL AND TIRE	
26A	362048	2	DRIVE WHEEL COMPLETE	
26B	323027	2	DRIVE WHEEL COMPLETE (32" ONLY)	
27A	363186	2	TIRE 13 X 6.5 X 6	
27B	323025	2	TIRE 13 X 5.00 X 6 (32" ONLY)	
28	363145	2	1" CLAMP COLLAR	
29	100273	3	5/16" X 1" HEX BOLT	
30	107501	1	3/8" X 2" CARRIAGE BOLT	
31	104256	3	5/16" NYLOC HEX NUT	
32A	362010	1	REAR DECK ASSY	
32B	322012	1	REAR DECK ASSY (32" ONLY)	
33	105258	2	5/16" STD FLAT WASHER	
34	363075	2	ROUND BELT GUIDE	
35	363226	4	DISC SPRING WASHER	
36	109018	4	8MM-1.25 x 25MM HEX BOLT (KAW)	
37	362031	1	BELT GUIDE BRKT (32" AND 36")	
38A	482003	1	BELT GUIDE BRKT (48" AND 60")	
38B	383003	1	BELT GUIDE BRKT (52")	

BELT DRIVE WALK BEHIND REAR DECK ASSEMBLY

SEE NOTES

#	PART NO.	QTY	DESCRIPTION
39	363169	1	SMALL IDLER
40	105260	1	3/8" STD FLAT WASHER
41	363220	1	TRANSMISSION SHEAVE
42	107262	1	KEY 1/4" SQ. X 2 1/2"
43	363119	1	PULLEY(TO TRANSMISSION)
44	363124	1	SPACER
45A	363216	1	TAPER LOCK SHEAVE
45B	823289	1	TAPER LOCK SHEAVE (52")
46	363215	1	1" TAPER LOCK HUB
47	363212	1	TRANSMISSION BELT
48	100271	4	5/16" X 3/4" HEX BOLT
49	523320	1	FLAT BELT GUIDE
50	363165	4	#2 HAIR PIN COTTER
51	363029	4	.312 ROD SWIVEL
52	363142	1	BRAKE ROD
54A	362041	1	BRAKE ARM RIGHT
54B	362042	1	BRAKE ARM LEFT
55	363177	4	3/8" PUSH NUT
56	363135	2	BRAKE CONNECTOR
57	108500	2	5/8" E-RING
58	362026	2	BRAKE CONNECTOR
59	100296	2	3/8" X 2" HEX BOLT
60	363176	2	BRAKE BAND
61	100252	8	1/4" X 3/4" HEX BOLT
62	602006	1	OIL DRAIN ASSY (16HP BRIGGS ONLY)
63	603031	1	DRAIN CLAMP (16HP BRIGGS ONLY)
64	603030	1	DRAIN CAP (16HP BRIGGS ONLY)
65	603029	1	DRAIN FITTING (16HP BRIGGS ONLY)
66	603026	1	ENGINE FITTING (16HP BRIGGS ONLY)
67	603025	1	DRAIN LINE (16HP BRIGGS ONLY)

NOTES:

1: Item refers to units prior to serial #27850

HANDLE ASSEMBLY

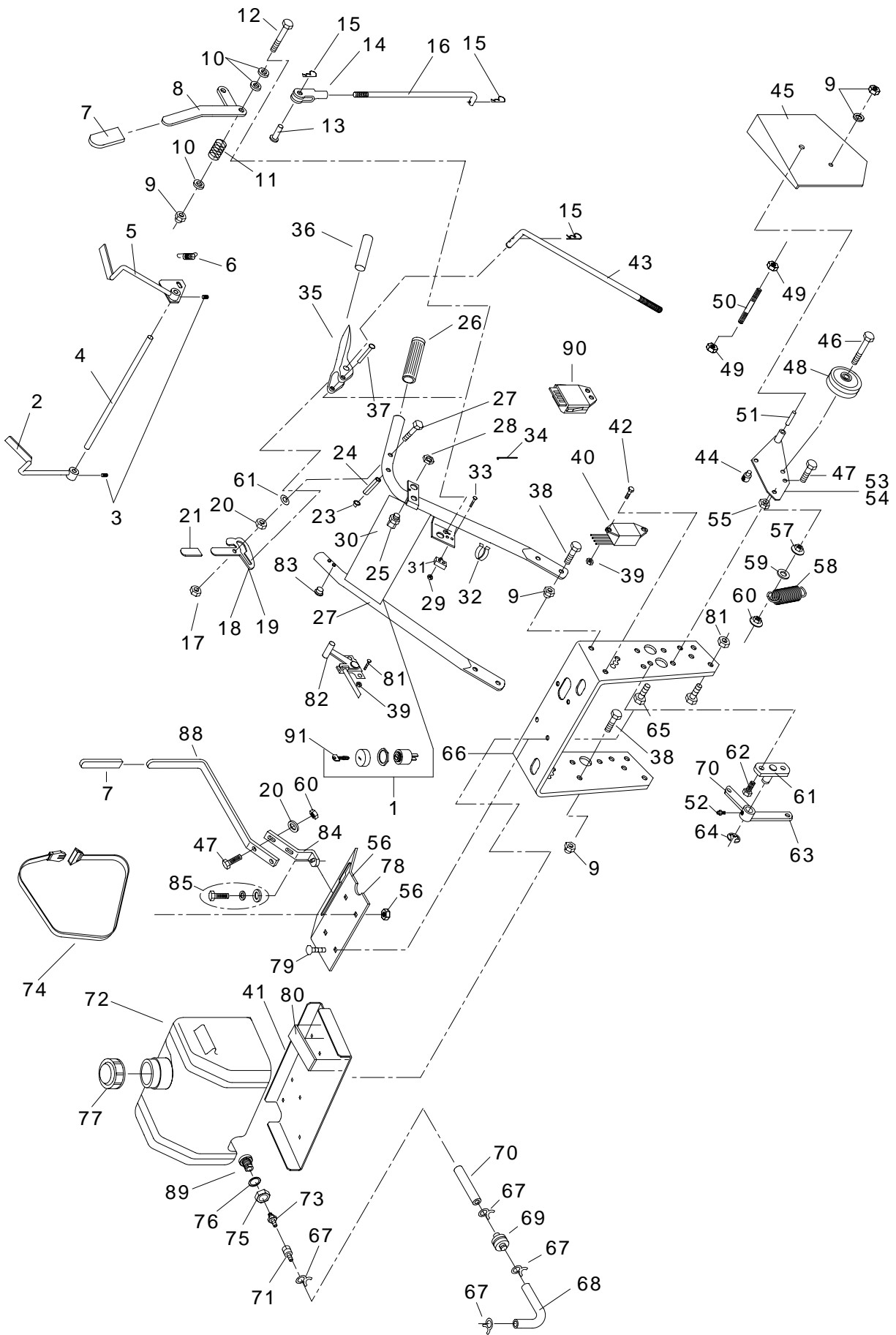

BELT DRIVE WALK BEHIND HANDLE ASSEMBLY

SEE NOTES

#	PART NO.	QTY	DESCRIPTION	
1	603060	1	RUN/STOP SWITCH-17HP KAW	
2	362051	1	RIGHT HAND O.P.C. LEVER	
3	103292	2	1/4"-28 X 1/4" SET SCREW	
4	363157	1	CONNECTING ROD	
5	362053	1	LEFT HAND O.P.C. LEVER	
6	363155	1	O.P.C. SPRING	
7	363022	2	ADJUSTMENT LEVER GRIP	
8	362058	1	ENGAGEMENT LEVER W/GRIP	
9	104257	1	3/8" NYLOC HEX NUT	
10	105260	3	3/8" STD FLAT WASHER	
11	363024	1	COMPRESSION SPRING	
12	100296	1	3/8" X 2" HEX BOLT	
13	363144	1	CLEVIS PIN-SMALL YOKE	
14	363152	1	YOKE-SMALL	
15	363165	3	HAIRPIN COTTER	
16	363150	1	UPPER CRANK LINKAGE	
17	103011	2	1/4" HEX TORQUE NUT	
18	363284	1	LEFT THUMB LATCH PKG.	
19	363282	1	RIGHT THUMB LATCH PKG.	
20	105258	2	5/16" FLAT WASHER	
21	363069	2	LATCH GRIP	
23	363219	2	3/16" PUSH NUT	
24	106340	2	5/16" X 1" ROLL PIN	
25	363208	1	O.P.C. SWITCH	
26	363218	2	HANDLE GRIP	
27	100258	2	1/4" X 2" HEX BOLT	
28	363234	1	NUT-O.P.C. SWITCH	
29	104520	2	#5-40 HEX NUT	
30A	362085	1	HANDLE/ W CONSOLE	
30B	362049	1	REPLACE W/362085 & 363352	1
31	363164	1	BLADE SWITCH	
32	363221	2	CABLE CLIP	
33	101252	2	#5-40 X 1" MACHINE SCREW	
34	363222	7	PLASTIC TIE	
35	362059	2	DRIVE LEVER W/GRIP	
36	363067	2	DRIVE LEVER GRIP	
37	363073	2	TRACTION LEVER PIN	
38	100292	8	3/8" X 1" HEX BOLT	
39	104252	1	#10-24 NYLOC HEX NUT	
40A	363387	1	WIRE HARNESS-(14HP KAW)	
40B	363388	1	WIRE HARNESS-(12 HP BRIGGS)	
40C	363237	1	WIRING HARNESS-(12HP BRIGGS)	1
--	-----	-	(REPLACE W/363388 & 363372)	
40D	363238	1	WIRING HARNESS-(14HP KAW)	1
--	-----	-	(REPLACE W/363387 & 363372)	

BELT DRIVE WALK BEHIND HANDLE ASSEMBLY

SEE NOTES

#	PART NO.	QTY	DESCRIPTION
40E	363270	1	WIRING HARNESS-KOHLER
40F	362074	1	WIRING HARNESS-HONDA
40H	603027	1	WIRING HARNESS-VANGUARD
40i	363371	1	WIRING HARNESS-17HP KAW
40J	363374	1	WIRING HARNESS-TECUMSEH
41	363360	1	TANK SADDLE
42	101039	1	#10-24 X 5/8" PANHEAD SCREW
43	363198	2	DRIVE ROD
44	363029	4	.312 SWIVEL
45A	363288	1	LEFT HAND FENDER
45B	363286	1	RIGHT HAND FENDER
46	100331	2	1/2" X 2 1/2" HEX BOLT
47	100274	4	5/16" X 1 1/4" HEX BOLT
48	363168	2	DRIVE IDLER
49	109007	4	3/8" WHIZLOCK NUT
50	363093	2	SAFETY SHIELD SUPPORT
51	363105	2	IDLER BUSHING
52	111004	2	1/4" -28 GREASE ZERK
53	362035	1	LEFT IDLER ARM (SHOWN)
54	362037	1	RIGHT IDLER ARM
55	104259	2	1/2" NYLOC HEX NUT
56	100502	6	1/4" NYLOC HEX NUT
57	109001	2	5/16" WHIZLOCK NUT
58	363117	2	TENSION SPRING
59	105257	4	5/16" S.A.E. FLAT WASHER
60	104256	2	5/16" NYLOC HEX NUT
61	362033	1	BELL CRANK MOUNT ASSY
62	100004	2	1/4" X 1" HEX BOLT
63	362040	1	BELL CRANK W/ZERK
64	108500	1	5/8" E-RING
65	100303	2	3/8" X 4" HEX BOLT
66	363148	1	LOWER HANDLE
67	363098	4	GAS LINE CLAMP
68	363228	1	SHORT FUEL LINE HOSE
69	363032	1	FUEL FILTER
70A	603032	1	FUEL LINE
70B	363099	1	FUEL LINE (V-TWINS)
71	363364	1	FUEL COUPLER-FEMALE
72	362087	1	MODULAR FUEL TANK
73	363353	1	FUEL COUPLER-MALE
74	363368	2	FUEL TANK BELT
75	104761	1	LEFT HAND NUT
76	363370	1	O-RING
77A	583194	1	FUEL CAP

BELT DRIVE WALK BEHIND HANDLE ASSEMBLY

SEE NOTES

#	PART NO.	QTY	DESCRIPTION	
77B	363257	1	FUEL CAP W/GASKET	1
78	363224	1	TANK SADDLE	
79	107502	4	1/4" X 3/4" CARRIAGE BOLT	
80	363201	2	FUEL TANK PAD	
81	101295	3	#10 X 1 1/2" SLTD. MACH. SCREW	
82A	363352	1	THROTTLE CONTROL	
82B	363203	1	THROTTLE CONTROL	1
--	-----	-	(12.5HP KAW & 13HP HONDA)	
82C	363268	1	THROTTLE CONTROL	1
--	-----	-	(14HP KOH & KAW & 12HP BRIGGS)	
82CD	603024	1	THROTTLE CONTROL	1
--	-----	-	(16HP & 18HP BRIGGS ONLY)	
83	363159	2	NYLON BUSHING	
84	363128	1	SHIFTER BRACKET	
85A	104251	1	3/8"-24 NYLOC HEX NUT	
85B	105260	1	3/8" STD FLAT WASHER	
85C	100502	1	1/4"-28 X 3/4" HEX BOLT	
85D	105004	1	1/4" LOCK WASHER	
85E	363226	1	SPRING DISC WASHER	
88	362060	1	SHIFTER LEVER W/GRIP	
89	363355	1	BULKHEAD FITTING	
90A	363372	1	SAFETY MODULE	
90B	363375	1	SAFETY MODULE TECUMSEH	
91	423209	1	IGNITION KEY	

NOTES:

1: Item refers to units prior to serial #28160

CASTER ASSEMBLY

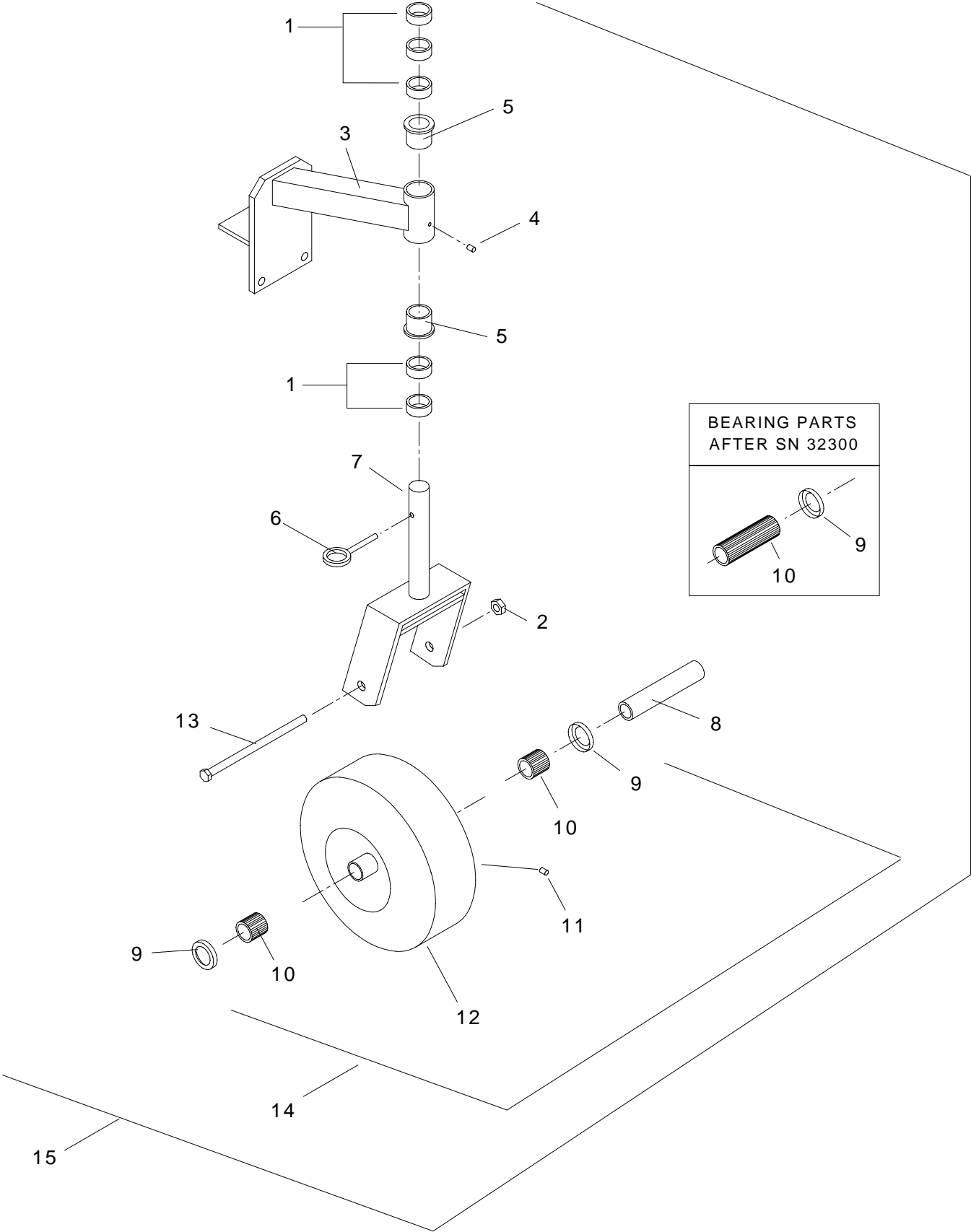

BELT DRIVE WALK BEHIND CASTER ASSEMBLY

SEE NOTES

#	PART NO.	QTY	DESCRIPTION	
1	363006	10	CASTER SPACER	
2	104259	2	1/2"-13 NYLOC NUT	
3	362007	2	CASTER SUPPORT W/BUSHINGS	
4	111001	2	GREASE ZERK	
5	363007	4	FLANGE BEARING	
6	109020	1	QUICK PIN	
7	362081	2	YOKE STRUT	
8	363307	2	AXLE TUBE	
9A	363011	4	END CAP	1
9B	423201	4	END CAP	
10A	363012	4	ROLLER BEARING	1
10B	423200	2	ROLLER BEARING	
11	111005	2	GREASE ZERK	
12	363360	2	SMOOTH TIRE AND TUBE	
13	100339	2	1/2"-13 X 6" BOLT	
14	363311	2	WHEEL COMPLETE	
15	362082	2	CASTER ASSY COMPLETE	

NOTES:

1: Item refers to units prior to serial #32300

ELECTRIC START ASSEMBLY

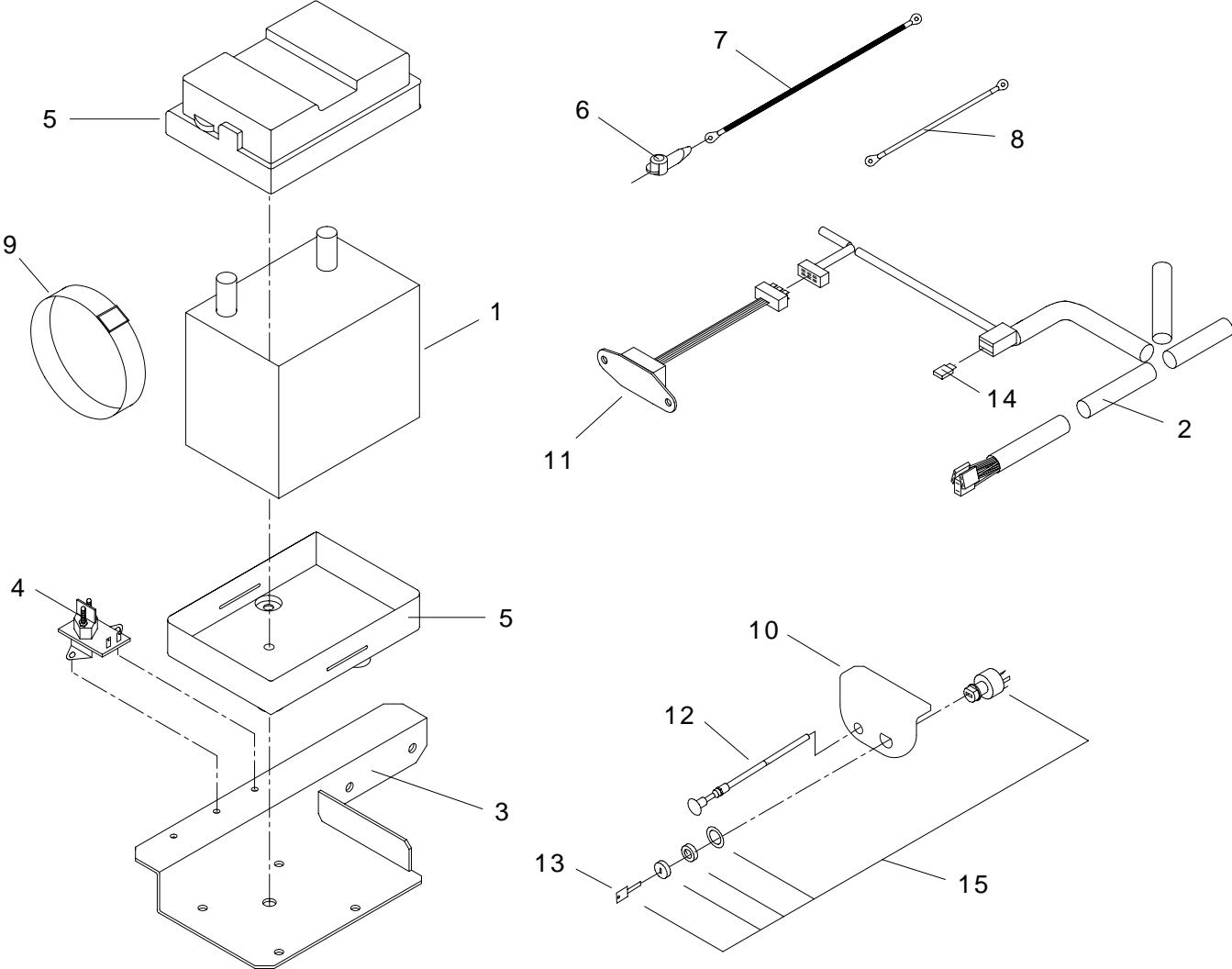

BELT DRIVE WALK BEHIND ELECTRIC START ASSEMBLY

SEE NOTES

#	PART NO.	QTY	DESCRIPTION	
1	423142	1	BATTERY	
2A	363373	1	WIRE HARNESS (KAW)	
2B	363344	1	WIRE HARNESS (BRIGGS)	
3	322017	1	BATTERY MOUNT BRACKET	
4	423017	1	STARTER RELAY	
5	363345	1	BATTERY CASE SET	
6	423158	3	TERMINAL INSULATOR	
7	423118	1	NEGATIVE CABLE	
8A	423116	1	POSITIVE CABLE (SHORT)	
8B	423117	1	POSITIVE CABLE (LONG)	
9	363349	1	BATTERY BELT	
10	363341*	1	SWITCH ANGLE	1
11	423030	1	SAFETY MODULE	
12A	423153	1	CHOKE CABLE (VANGUARD)	
12B	523027	1	CHOKE CABLE (KAW)	1
13	423209	1	IGNITION KEY	
14	523145	1	20 AMP FUSE	
15	423027	1	IGNITION SWITCH ASSEMBLY	

NOTES:

1: Item refers to units prior to serial #28160

BELT DRIVE WALK BEHIND DECALS



1



2



3



4



5



6



7



8



9



10



11



12



13



14



15



16



17

BELT DRIVE WALK BEHIND DECALS

#	PART NO.	QTY	DESCRIPTION
1	363369	1	Premier Series Decal
2	363037	1	Cutter Blade Label
3	363039	1	Throttle Decal
4	363289	2	Neutral Park Decal
5	363038	1	Caution/Instr. Label
6	363001	1	Caution Decal
7	363023	1	Danger Decal
8	363232	1	Encore Logo
9	363231	1	Encore Label
10	363214	1	Pro-Line Decal
11	363241	1	Gear Shift Label
12	363233	1	Shifting Label
13	323038	1	Pro 32 Decal
14	363356	1	Pro 36 Decal
15	483075	1	Pro 48 Decal
16	523467	1	Pro 52 Decal
17	603057	1	Pro 60 Decal

Notes:

